

RELO BS

DECK FASCIA BRACKET SET

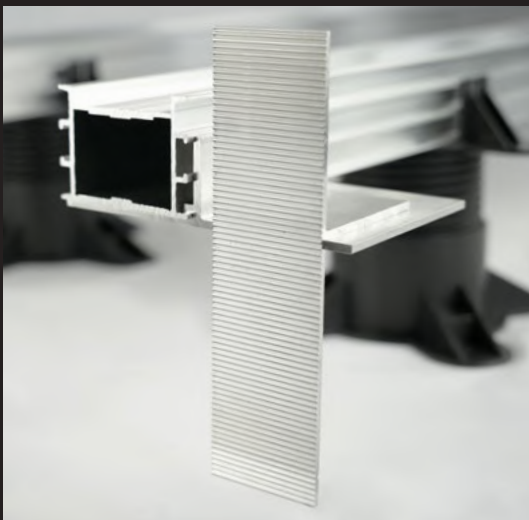

The **RELO BS** deck fascia bracket set enables quick and easy installation of continuous fascia boards around the entire perimeter of a deck.

Whether installed parallel or end-on to the substructure, clean and secure connections can be effortlessly achieved.

Thanks to the high material thickness, the system offers outstanding stability and reliable support for the attached fascia elements.

Fascia boards can be made from standard decking boards or combined with RELO V ventilation profiles, which provide optimal cross ventilation underneath the deck.

The fascia brackets feature pre-marked cut lines for easy height adjustment, allowing for flexible use. Fascia heights of up to 180 mm are easily accommodated.

RELO BS		
Description	PU	Prod. No.
Bracket Set	4 PCS	046104000



SET-PACK

Each package contains the UNIA 4.2x22 mm screws (for positioning the support profile and securing the fascia brackets) and PROFILA 5.5 x 45 mm screws (for fixing timber fascia boards) required for installation and assembly instructions



BRANDING

Custom branding upon request

DOWNLOADS



Installation



Data Sheet



Tips & Tricks



Configurator

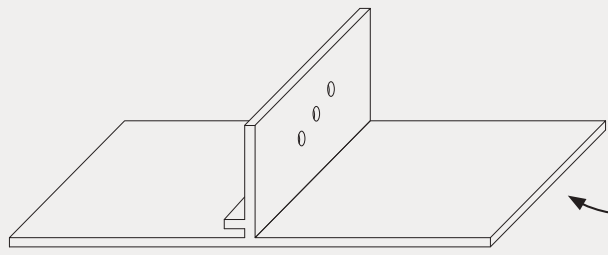

SUPPORT PROFILE

Maximum load-bearing capacity with 3 mm material thickness

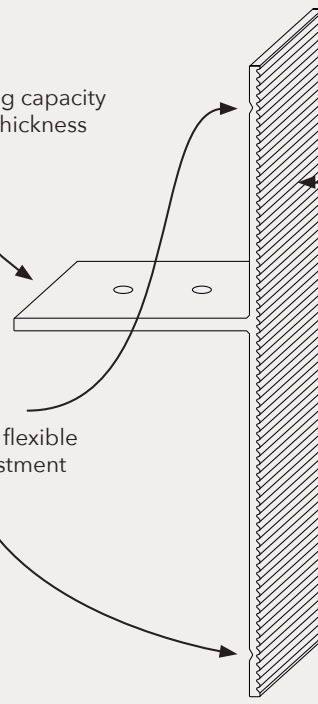

2.5 mm reinforced screw zone for secure attachment of fascia boards

Pre-marked cut lines for flexible height adjustment

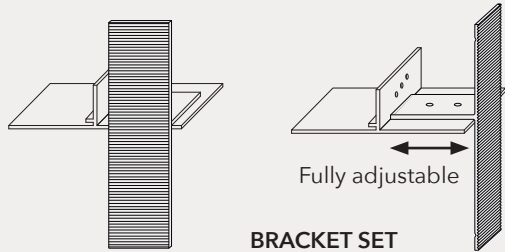

BRACKET SET

FASCIA BRACKET

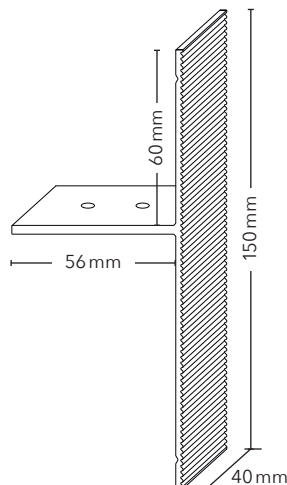
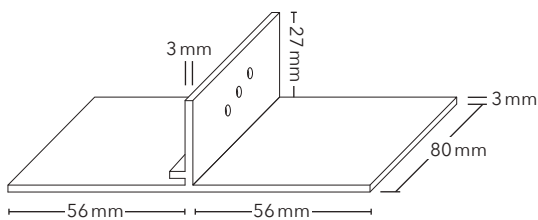
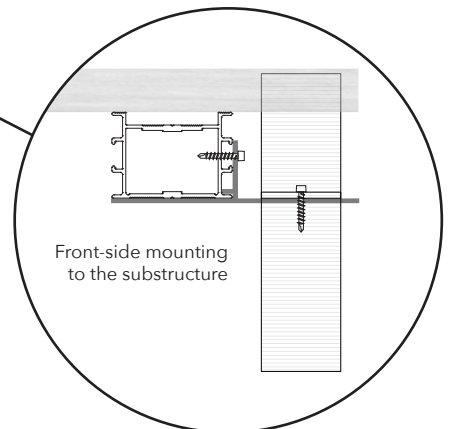
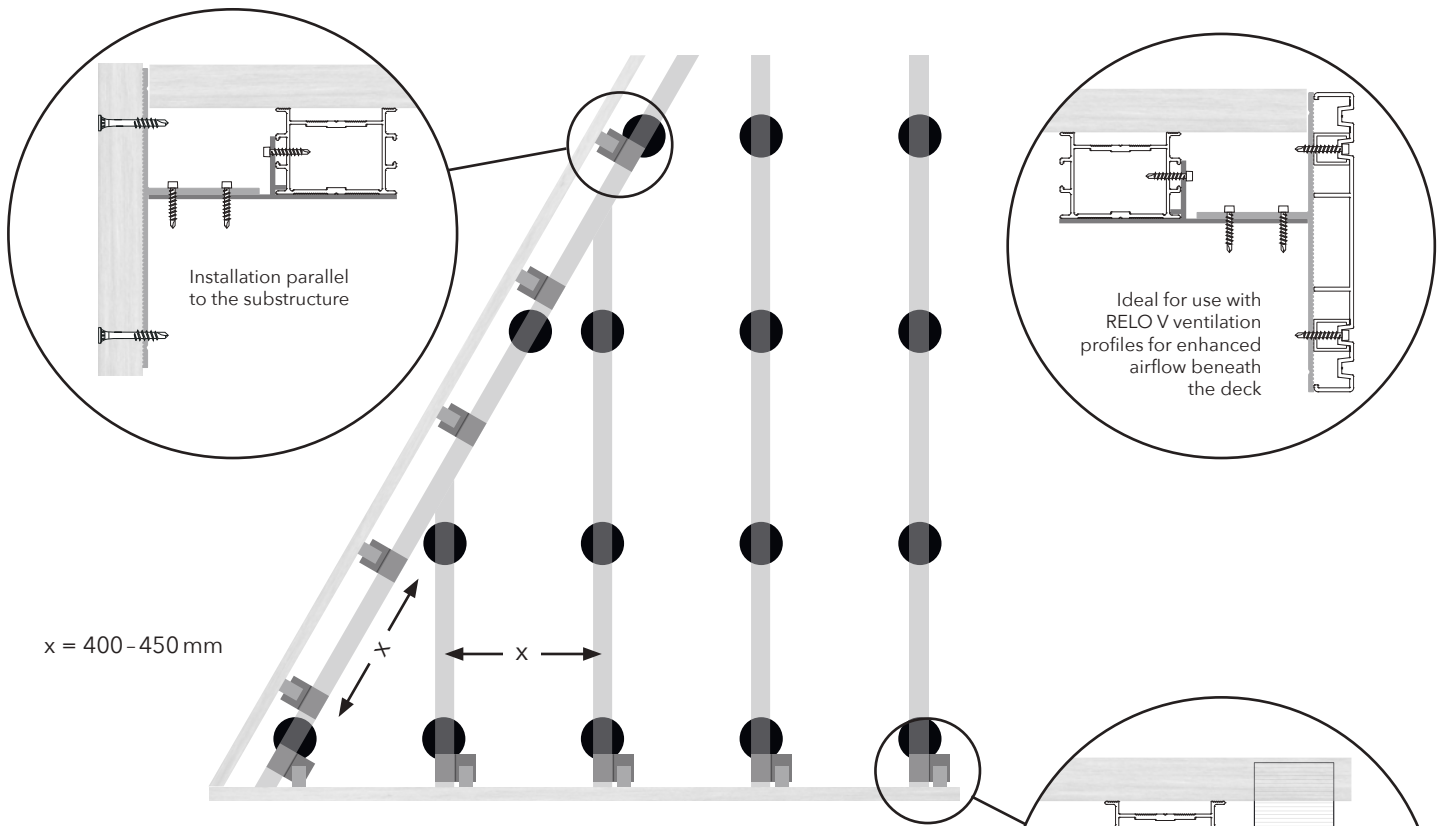

OVERVIEW	
Dimensions:	As shown in diagram
Material:	Solid aluminium, mill finish